

Safety temperature limiter STB

For monitoring temperatures in heating water, hot water systems and other applications in heating, ventilation and air conditioning systems. When the setpoint temperature is reached, the 1-pin changeover contact (SPDT) is switched and mechanically locked.

Manufacturer:
 JUMO GmbH & Co. KG
 Fulda - Deutschland
 Item No.: 60730/0070-5-059-..

Type Overview

Type	Output signal temperature switch	Additional features	Capillary
EXT-J-00734645	Changeover	Manual reset	1 m

Technical Data

Electrical data	Electrical connection	Spring loaded terminal block max. 2.5 mm ²
	Cable entry	Cable gland with strain relief M20x1.5 mm, for cable Ø6...12 mm
Functional data	Output signal passive temperature	Changeover
	Output signal temperature switch note	AC 230 V 16 (2.5) A @ Switch position 1-2 AC 230 V 2 (0.4) A @ Switch position 1-4
	Switching reliability	min. switching current 100 mA @ AC 24 V
	Application	Air/Water
Measuring data	Measuring values	Temperature
	Measuring range temperature	50...80°C
	Setting range Temperature	50...80°C
	Accuracy temperature passive	+0K / -8K (lower half, 50...65°C) +0K / -5K (upper half, 65...80°C)
Materials	Cable gland	PA6, black
	Housing	Bottom: PA (RAL7001, silver grey) Cover: ABS with inspection glass (PMMA) Seal: NBR
Safety data	Capillary	Copper
	Ambient humidity	Max. 95% r.H., non-condensing
	Ambient temperature	0...80°C
	Fluid temperature	Up to max. 110°C
	Storage temperature	-30...80°C
	EU Conformity	CE Marking
	Certification IEC/EN	DIN EN 60730-1 and DIN EN 14597
	Pressure equipment directive	CE according to 2014/68/EU
	Degree of protection IEC/EN	IP54
	Degree of protection note	IP protection with mounted sealing elements
	Quality Standard	ISO 9001
Mode of operation	Type 2BFHKLNPV	

Safety notes



This device has been designed for use in stationary heating, ventilation and air-conditioning systems and must not be used outside the specified field of application. Unauthorised modifications are prohibited. The product must not be used in relation with any equipment that in case of a failure may threaten humans, animals or assets.

Ensure all power is disconnected before installing. Do not connect to live/operating equipment.

Only authorised specialists may carry out installation. All applicable legal or institutional installation regulations must be complied during installation.

The device contains electrical and electronic components and must not be disposed of as household refuse. All locally valid regulations and requirements must be observed.



During installation, testing, servicing and troubleshooting of this product, it may be necessary to work with live electrical components. Have a qualified licensed electrician or other individual who has been properly trained in handling live electrical components perform these tasks. Failure to follow all electrical safety precautions when exposed to live electrical components could result in death or serious injury.

Remarks

Switching function

If the temperature on the sensor exceeds the setpoint value, the changeover is activated by the transmission mechanics and the electrical circuit is opened resp. closed and the changeover is mechanically locked.

The unlocking difference is about 10K. If the temperature falls below the selected setpoint value then the changeover can be manually unlocked again.

Reset function

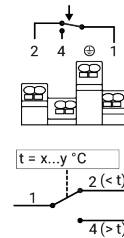
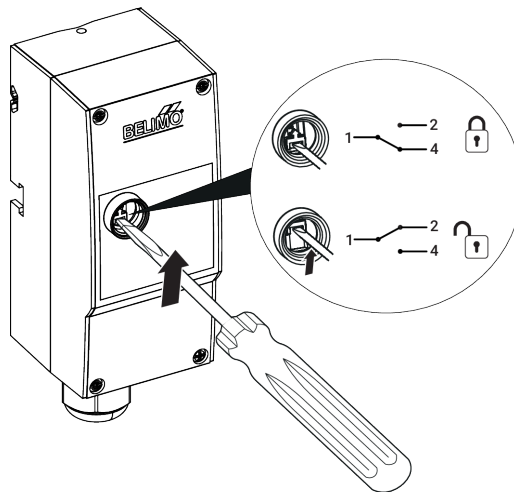

Installation notes

Installation situation The safety temperature limiter can be installed in four different ways.

Pipe contact mounting

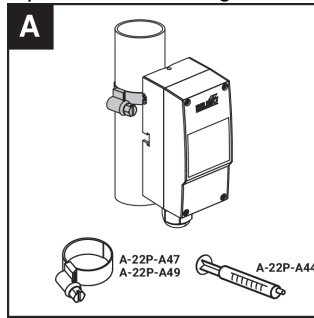

The tightening strap is included in the scope of delivery

Thermowell mounting

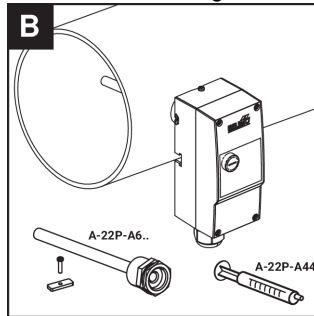

The thermowell A-22P-A6... is available as an optional accessory

Wall mounting with probe in flange

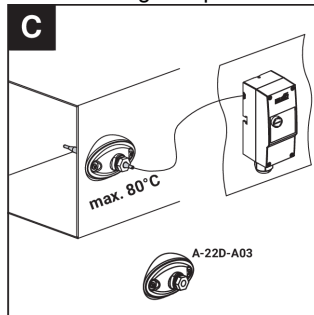

The A-22D-A03 flange is available as an optional accessory

Wall mounting with probe in immersion sleeve

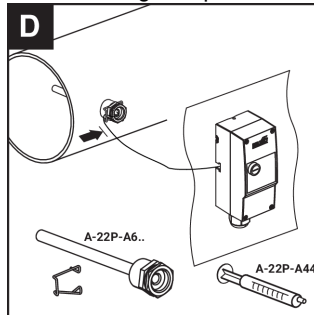

The thermowell A-22P-A6... is available as an optional accessory

Scope of delivery

Tightening strap for pipes from Ø15...100 mm

Accessories

Optional accessories	Description	Type
	Syringe with thermal paste	A-22P-A44
	Fixing strap, for pipes up to Ø 40...110 mm [1.6...4.3"]	A-22P-A47
	Fixing strap, for pipes up to Ø 40...250 mm [1.6...9.8"]	A-22P-A49
	Mounting flange for sensor probe 6 mm, up to max. 120°C [248°F], Plastic	A-22D-A03
Recommended accessories water	Description	Type
	Thermowell pocket kit (fabricated) Brass nickel-plated, 100 mm, G1/2", SW22	A-22P-A61
	Thermowell pocket kit (fabricated) Brass nickel-plated, 150 mm, G1/2", SW22	A-22P-A62
	Thermowell pocket kit (fabricated) Brass nickel-plated, 200 mm, G1/2", SW22	A-22P-A63
	Thermowell pocket kit (fabricated) Stainless steel, 100 mm, G1/2", SW22	A-22P-A64
	Thermowell pocket kit (fabricated) Stainless steel, 150 mm, G1/2", SW22	A-22P-A65
	Thermowell pocket kit (fabricated) Stainless steel, 200 mm, G1/2", SW22	A-22P-A66

Wiring diagram

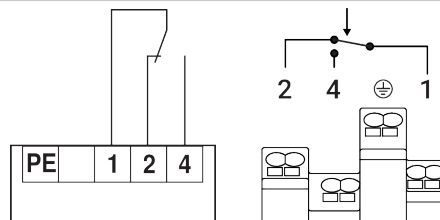

Dimensions

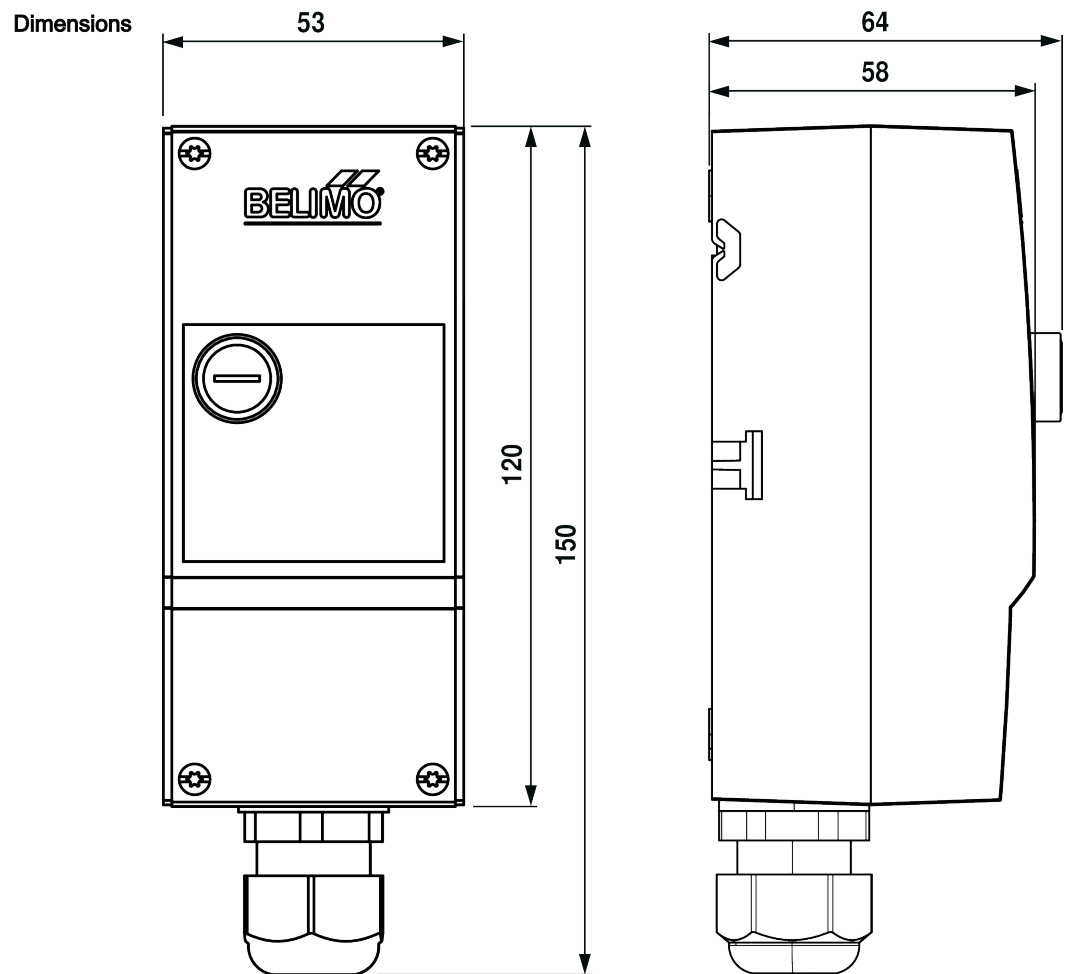

Type	Weight
EXT- J-00734645	0.3 kg