



Damper actuator for adjusting air control dampers in ventilation and air-conditioning systems for building services installations

- For air dampers up to approx. 0.8 m²
- Torque 4 Nm
- Nominal voltage AC/DC 24 V
- Control: Open-close
(not made for 3-point applications)
- Running time 2.5 s



Technical data

Electrical data	Nominal voltage	AC 24 V, 50/60 Hz / DC 24 V
	Nominal voltage range	AC 19.2 ... 28.8 V / DC 21.6 ... 28.8 V
	Power consumption	In operation 13 W @ nominal torque At rest 2 W For wire sizing 23 VA (I max. 20 A @ 5 ms)
	Connection	Cable 1 m, 3 x 0.75 mm ²
Functional data	Torque (nominal torque)	Min. 4 Nm @ nominal voltage
	Direction of rotation	Reversible with switch 0 ↺ resp. 1 ↻
	Manual override	Gearing latch disengaged with pushbutton, can be locked
	Angle of rotation	Max. 95° ↺, can be limited at both ends with adjustable mechanical end stops
	Angle of rotation limiting	min. 30° ↺
	Running time	2.5 s / 90° ↺
	Automatic adjustment of operating range to match the mechanical angle of rotation	Manual triggering of the adaption by pressing the «Adaption» button
	Sound power level	52 dB (A)
	Position indication	Mechanical, pluggable
	Negative torque	 ≤50% from nominal torque (Caution: can only be used with restrictions. Please contact your Belimo representative.)
Safety	Protection class	III Safety extra-low voltage UL Class 2 Supply
	Degree of protection	IP54 in any mounting position NEMA 2, UL Enclosure Type 2
	EMC	CE according to 2004/108/EC
	Certification	Certified to IEC/EN 60730-1 and IEC/EN 60730-2-14 cULus according to UL 60730-1A and UL 60730-2-14 and CAN/CSA E60730-1:02
	Mode of operation	Type 1
	Rated impulse voltage	0.8 kV
	Control pollution degree	3
	Ambient temperature	-30 ... +40 °C (no restrictions)  +40 ... +50 °C (Caution: can only be used with restrictions. Please contact your Belimo representative.)
	Non-operating temperature	-40 ... +80 °C
	Ambient humidity	95% r.H., non-condensating
Maintenance	Maintenance-free	
Dimensions / Weight	Dimensions	See «Dimensions» on page 3
	Weight	Approx. 850 g

Safety notes



- The actuator is not allowed to be used outside the specified field of application, especially in aircraft or in any other airborne means of transport.
- It may only be installed by suitably trained personnel. Any legal regulations or regulations issued by authorities must be observed during assembly.
- The device may only be opened at the manufacturer's site. It does not contain any parts that can be replaced or repaired by the user.
- The cable must not be removed from the device.
- Adaptation is necessary when the system is commissioned and after each adjustment of the angle (press the adaptation push-button)
- When calculating the required torque, the specifications supplied by the damper manufacturers (cross section, design, installation site), and the air flow conditions must be observed.
- The device contains electrical and electronic components and is not allowed to be disposed of as household refuse. All locally valid regulations and requirements must be observed.

Product features

- Simple direct mounting** Simple direct mounting on the damper spindle with a universal spindle clamp, supplied with an anti-rotation strap to prevent the actuator from rotating.
- Manual override** Manual override with push-button possible (the gear is disengaged for as long as the button is pressed or remains locked).
- Adjustable angle of rotation** Adjustable angle of rotation with mechanical end stops.
A minimum permissible angle of rotation of 30° must be allowed for.
- High functional reliability** The actuator is overload-proof, requires no limit switches and automatically stops when the end stop is reached.
- Home position** The first time the supply voltage is switched on, i.e. during initial startup, the actuator carries out an adaptation. After pressing the «gear disengagement» pushbutton, the actuator moves to the home position at the end stop.

Pos.	Direction of rotation	Home position
0	0	ccw ↺ Left stop
1	1	↻ cw Right stop

The actuator then moves into the position defined by the control signal.

- Adaption and synchronisation** During adaptation, the upper and lower spindle end stop is recorded and deposited in the actuator. Detection of the mechanical end stops enables a gentle approach to the end positions and thus protects the actuator mechanism.
During synchronisation, the actuator moves to the home position for angle referencing. This ensures correct position regulation.

Accessories

	Description	Data sheet
Electrical accessories	Auxiliary switch S..A..	T2 - S..A..
	Feedback potentiometer P..A..	T2 - P..A..
	Adapter Z-SPA Ordering of this adapter is compulsory if an auxiliary switch or a feedback potentiometer is required and the clamp is simultaneously mounted on the rear of the actuator (e.g. with short-spindle mounting).	
Mechanical accessories	Various accessories (clamps, shaft extensions etc.)	T2 - Z-NM..A..

Electrical installation

Wiring diagram

Note

- Connect via safety isolation transformer.
- Parallel connection of other actuators possible. Note performance data for supply.

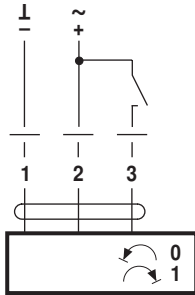

Cable colours:

- 1 = black
- 2 = red
- 3 = white

Direction of rotation



Operating controls and indicators

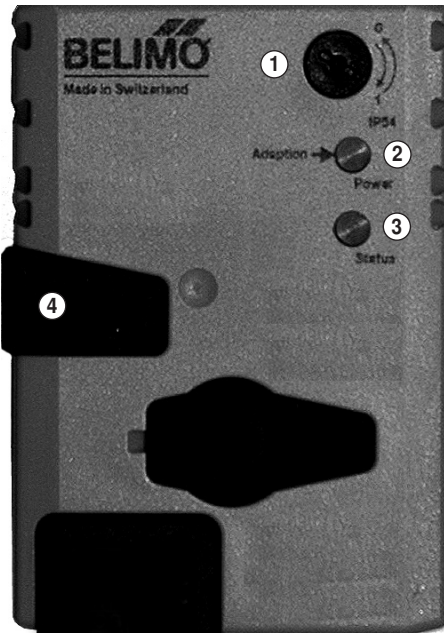

① Direction of rotation switch

Switching over: Direction of rotation changes

② Push-button and green LED display

- Off: No voltage supply or fault
- On: In operation
- Press button: Switches on angle of rotation adaptation followed by standard operation

③ Push-button and yellow LED display

- Off: Standard operation
- On: Adaptation or synchronising process active
- Press button: No function

④ Gear disengagement switch

- Press button: Gear disengaged, motor stops, manual override possible
- Release button: Gear engaged, synchronisation starts, followed by standard operation

Check voltage supply connection

- a) ② Off and ③ On } Check the supply connections.
- b) ② Blinking and ③ Blinking } Possibly \perp and ∇ are swapped over.

Dimensions [mm]

Dimensional drawings

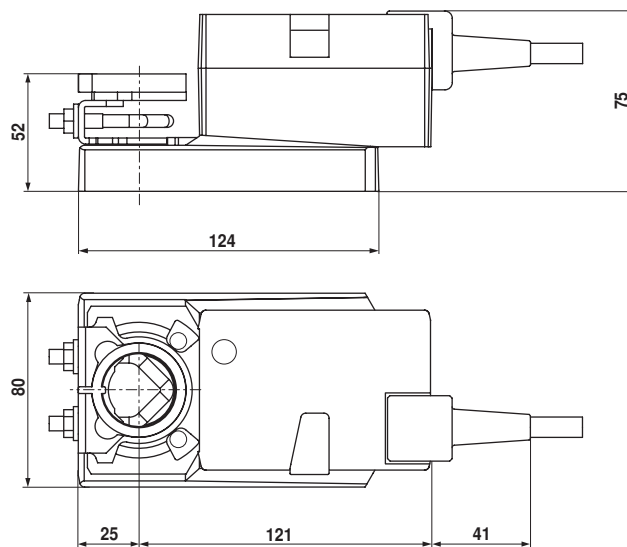

Damper spindle	Length	⊙	□	◇
	≥40	8 ... 26.7	≥8	≤26.7
	≥20	8 ... 20	≥8	≤20

* Option (accessory K-NA)
When using an auxiliary switch or feedback potentiometer see «Accessories».

1

	A			
LMQ24A..	≥ 40	8 ... 26.7	≥ 8	≤ 26.7
NMQ24A..	≥ 42	8 ... 26.7	≥ 8	≤ 26.7

2

3

4

9Nm

1mm

5

Z-PI

65°

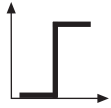

AC 24 V / DC 24 V

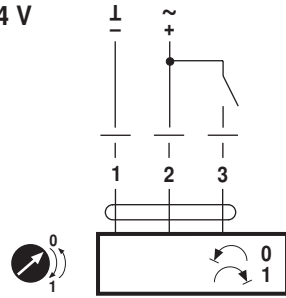

LMQ24A..
NMQ24A..

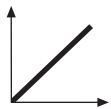

AC 24 V / DC 24 V

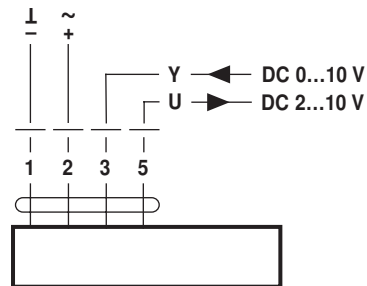

LMQ24A-SR..
LMQ24A-MF..
LMQ24A-SRV-ST
NMQ24A-SR..
NMQ24A-MF..
NMQ24A-SRV-ST